

Rev. No.	Revision Note	Date	By	Checked
A1	Brackets Revised	04-FEB-14	AH	YM

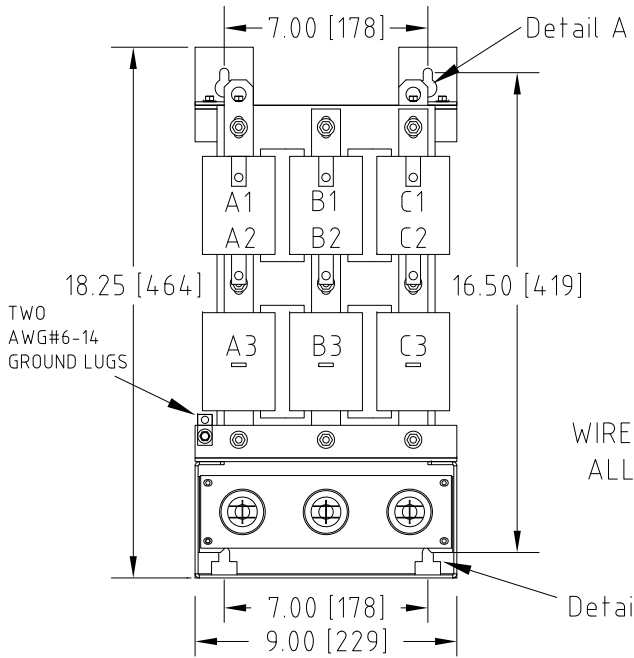

Front View

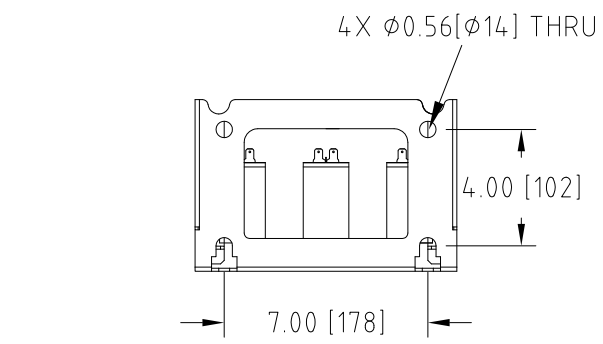

Bottom View

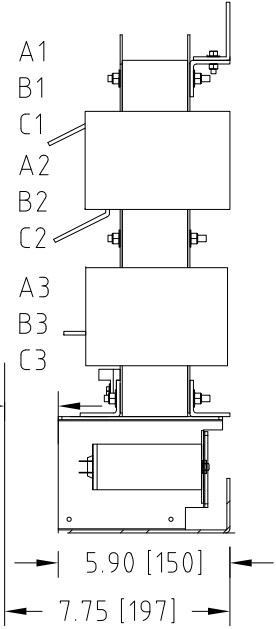

Side View

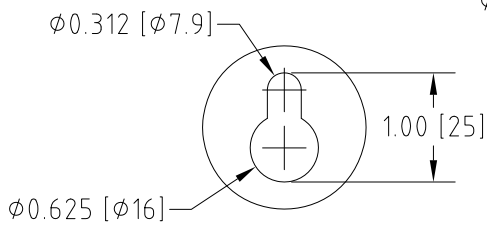

Detail A

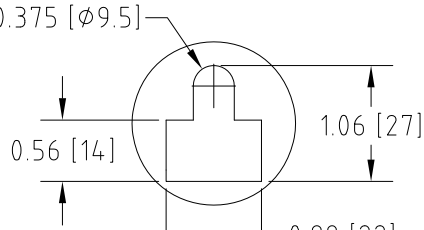

Detail B

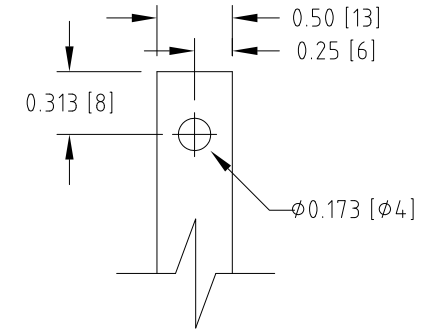

Input A1,B1,C1 & Output A2,B2,C2
TERMINALS
THICKNESS: 1/8"

Connection Diagram

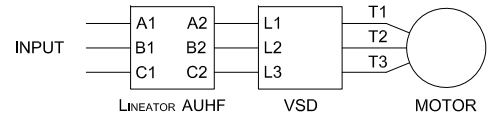

UNIT SPECIFICATIONS			INPUT	OUTPUT	APPROX. WT,
HP (kW)	PHASE	VOLTS	AMPS	kW	lb (kg)
7.5 (5.5)	3	600	7	6.3	77 (35)

- NOTES:
1. CUSTOMER IS RESPONSIBLE FOR INSTALLATION TO MEET ALL NATIONAL AND LOCAL ELECTRICAL CODES AND OTHER APPLICABLE ELECTRICAL SAFETY AUTHORITIES.
 2. CUSTOMER IS RESPONSIBLE FOR PROPER COOLING OF FILTER COMPONENTS. ALLOWED AMBIENT: MAXIMUM 60°C, MINIMUM -40°C. A MINIMUM CLEARANCE OF 2" MUST BE ALLOWED ON BOTH RIGHT AND LEFT SIDES. PROPER VENTILATION MUST ENSURE THAT SUPPLY AIR FLOWS THROUGH THE REACTOR COILS FROM BELOW THE UNIT.

MIRUS International Inc. 31 Sun Pac Boulevard, Brampton, ON, Canada L6S 5P6
Tel: (905) 494-1120 Fax: (905) 494-1140 Toll Free: 1-888-TO MIRUS

Unless otherwise specified, dimensions are in inches and [mm].	Drawn by WXY	Date 22-OCT-09	Checked by YM	Approved by - date YM - 22-OCT-09	Scale NTS
The information contained herein is the sole property of MIRUS International Inc. Any form of reproduction, distribution and/or disclosure of this information, all or in part, is strictly prohibited without the express written consent of MIRUS International Inc.		Title 7.5HP, 600V, 60Hz Lineator AUHF (Panel Mount)			
		Filename AUHF-7-600-60-D-E0P-A1	Revision A1	Sheet 1/1	