

THE LINEATOR™
ADVANCED UNIVERSAL HARMONIC FILTER (AUHF)

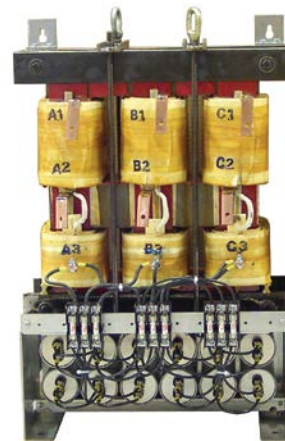

IMPORTANT SAFETY INSTRUCTION

SAVE THESE INSTRUCTIONS - This manual contains important instructions for the Lineator™ AUHF that must be followed during installation, operation, and maintenance of the Lineator™ AUHF and its auxiliary equipment.



WARNING

OPENING ENCLOSURES EXPOSES HAZARDOUS VOLTAGES.
ALWAYS REFER SERVICE TO QUALIFIED PERSONNEL ONLY.



WARNING

As standards, specifications, and designs are subject to change, please ask for confirmation of the information given in this publication.

This manual is a controlled document; pages should not individually be removed from this document.

THE LINEATOR™
ADVANCED UNIVERSAL HARMONIC FILTER (AUHF)

**INSTALLATION, OPERATION AND
MAINTENANCE GUIDE**

AUHF-M001-A16
04-Feb-2022

MIRUS International Inc.
31 Sun Pac Blvd.
Brampton, Ontario
Canada L6S 5P6

1 - 888 - TO – MIRUS (1 - 888 - 866 – 4787)
Tel: (905) 494-1120
Fax: (905) 494-1140
E-Mail: mirus@mirusinternational.com
Website: www.mirusinternational.com

The Lineator™ Advanced Universal Harmonic Filter (AUHF) 5 to 3500 HP Owner's Manual

Warranty

1. **Warranty:** MIRUS International Inc. (MIRUS) warrants to the end-user (the Customer) of the LINEATOR™ Advanced Universal Harmonic Filter (AUHF) as follows:

- (a) The LINEATOR™ AUHF will be free from defects in materials and workmanship under normal use and service for a period of three (3) years from the date of shipment. Normal use and service includes environments where background voltage distortion is up to 8%, with no individual harmonic > 5%, as allowed by IEEE Std 519-2014.
- (b) The LINEATOR™ AUHF will perform as advertised to reduce harmonic distortion caused by AC Variable Speed Drives, DC Drives and other non-linear loads equipped with 3-phase, 6-pulse, diode or SCR bridge rectifiers (half-wave rectifiers excluded). A properly selected and installed LINEATOR™ will:
 - (i) Reduce Current Total Harmonic Distortion (ITHD), measured at the LINEATOR™ input terminals at full load, without the need of additional AC or DC reactors, to:
 - (1.) < 8% when background voltage distortion is < 5% and voltage imbalance is < 3%
 - (2.) < 5% when High Performance (HP) model is purchased and background voltage distortion is < 2% and voltage imbalance is < 2% (not available for SCR bridges)
 - (ii) Reduce Current Total Demand Distortion (ITDD), measured at the LINEATOR™ input terminals over its entire operating range, to levels defined in Item 1 above. ITDD is defined as the ratio of ITHD divided by the full load current (peak demand current) of the LINEATOR™.
 - (iii) Minimize the contribution to Voltage Harmonic Distortion of all VSD's equipped with the LINEATOR™ to < 5% total and < 3% for individual harmonics to meet IEEE Std 519-1992 and 2014 requirements.
 - (iv) NOT become overloaded by other upstream harmonic sources.
 - (v) NOT resonate with other power system components.
 - (vi) NOT have compatibility problems with engine generator sets properly sized for the load.
 - (vii) If equipped with Coordinated Surge Protection (CSP) option, full LINEATOR™ product warranty is extended to five (5) years under the same terms and conditions stated herein.

2. **Limitation:** The foregoing warranties shall not apply and shall be void if the LINEATOR™ AUHF has been subject to misuse, abuse, accident, disaster, or has been operated contrary to MIRUS' instructions relating to installation, maintenance, use or operation.

3. **Exclusive Remedy:** If the LINEATOR™ AUHF does not conform with the warranties set out above, the Customer must notify MIRUS of the defective unit within the applicable warranty period and obtain a written return material authorization (an "RMA") from MIRUS. The Customer must return the defective unit to MIRUS, freight prepaid, within sixty (60) days of receipt of the RMA and must include a copy of MIRUS' paid invoice for the defective unit and a description of the defective unit's failure to conform. If MIRUS agrees that the returned unit is defective, MIRUS' entire obligation and liability shall be, in MIRUS' sole discretion, to repair or replace the defective unit or give a full refund of the purchase price to the Customer.

THE FOREGOING IS THE CUSTOMER'S SOLE AND EXCLUSIVE REMEDY FOR BREACH OF WARRANTY BY MIRUS WITH RESPECT TO THE LINEATOR™ AUHF.

4. **Replacement or Repaired Product Warranty:** Any repaired or replaced LINEATOR™ AUHF shall be warranted as set forth herein for the remainder of the applicable warranty period of the original unit or for three (3) months, whichever is greater.

Service and Factory Repair - Call 1 - 888 - TO - MIRUS (1 - 888 - 866 - 4787)

Direct questions about the operation, repair, or servicing of this equipment to MIRUS International Inc. Customer Support Services. Include the part number, assembly number, and serial number of the unit in any correspondence. Should you require factory service for your equipment, contact MIRUS International Inc. Customer Support Services and obtain a Return Materials Authorization (RMA) prior to shipping your unit. Never ship equipment to MIRUS International Inc. without first obtaining an RMA.

Proprietary Rights Statement

The information in this manual is the property of MIRUS International Inc., and represents a proprietary article in which MIRUS International Inc., retains any and all patent rights, including exclusive rights of use and/or manufacture and/or sale. Possession of this information does not convey any permission to reproduce, print, or manufacture the article or articles shown herein. Such permission may be granted only by specific written authorization, signed by an officer of MIRUS International Inc.

LINEATOR™ is a trademark of MIRUS International Inc. Other trademarks that may be used herein are owned by their respective companies and are referred to in an editorial fashion only.

Revision History

Copyright ©	All rights reserved. Printed in Canada
Revision: A16	New Release 2022/02/04

Contents

Introduction

Section	Description	Page
1.0	General Information	1
1.1	General	1
2.0	Product Description and Application	1
2.1	Description	1
2.2	Harmonics from other Sources	1
2.3	System Resonance	1
2.4	Leading Power Factor	1
2.5	Harmonic Distortion Reduction	1
2.6	Isolation Transformers	1
3.0	Installation	2
3.1	Location	2
3.2	Inspection and Energization	2
3.3	Handling	2
3.4	Grounding	3
4.0	Storage	3
5.0	Maintenance	3
5.1	Periodic Inspection and Maintenance	3
5.2	Cleaning	4
5.3	Drying of Core and Coil Assembly	4
6.0	Operation	4
6.1	Effect of Humidity	4
6.2	Loading	4
7.0	Technical Data	5
7.1	General Specifications	5
7.2	Connection Diagrams	5
7.3	Lineator Rating Table	6
7.4	Recommended Circuit Breaker or Fuse Protection.....	8
7.5	Lineator Type Operational Curve	9
7.6	Enclosure Dimensions	10
8.0	Troubleshooting Guide	11

1.0 General Information

1.1 General

Lineators™ are manufactured to provide optimum performance for a lifetime of uninterrupted service. Careful attention to the following instructions is recommended for safe and reliable operation.

Installation, operation and maintenance of Lineators™ should be performed by authorized persons, familiar with electrical apparatus and the potential hazards involved.

	<p>WARNING</p> <p><i>Danger! There is the potential of electric shock whenever working in or around electrical equipment such as the Lineator™. Power must be shut off before any work is conducted on a Lineator™.</i></p>
---	--

As with any electrical device, Lineators™ must be installed according to the requirements of the national and local electrical codes.

2.0 Product Description and Application

2.1 Description

The Lineator™ is a purely passive device consisting of a revolutionary new inductor combined with a relatively small capacitor bank. Its innovative design achieves cancellation of all the major harmonic currents generated by VSD's and other similar 3-ph, 6-pulse rectifier loads (resulting in THID of < 8% and often as low as 5%). Although referred to as a filter, the Lineator™ exhibits none of the problems that plague conventional filters.

2.2 Harmonics from other Sources

The Lineator™ will present a high impedance to line side harmonics, thus eliminating the possibility of attracting harmonics from upstream non-linear loads.

2.3 System Resonance

The natural resonance frequency of the Lineator™ is below that of any predominant harmonic, therefore inadvertent resonance is avoided.

2.4 Leading Power Factor

The leading PF of the Lineator™ at light loads consists of very low capacitive reactance <15% of rated kVA for units larger than 75HP. In the majority of applications, switching out capacitors under no load conditions is not necessary when using the Lineator™.

2.5 Harmonic Distortion Reduction

The Lineator™ will reduce current distortion to < 8% and typically achieves near 5% THID when operating near full load.

2.6 Isolation Transformers

The high let-through impedance of the Lineator™ will provide many of the same benefits as the drive isolation transformer, while also dramatically reducing the harmonics injected into the power system by the drive. It accomplishes this in a much smaller footprint, so when there is no need for voltage transformation, the use of the Lineator™ eliminates the need for a drive isolation transformer. And when voltage transformation is required, the isolation transformer will not require a K-factor rating.

3.0 Installation

3.1 Location

Location of the Lineator™ should be made with consideration given to accessibility, ventilation and atmospheric conditions. Installation locations should be free of contaminants including dust, fertilizer, excessive moisture, corrosive gases, flammable materials or chemical fumes. Filtered air may be considered to reduce maintenance where air born contaminants are a problem.

Sufficient clearances from walls and other obstructions should be provided to permit unrestricted opening of hinged and removable doors, covers and panels for the purpose of wiring terminations, inspection, maintenance and testing. Also, **proper ventilation requires at least 6 in. (155mm) clearance** at all ventilation openings, with the exception of the rear face of wall mountable enclosures such as the SU1, SU2, SU3 and SU4 type enclosures. Ambient temperature must not exceed 104 Deg F (40 Deg C). In enclosed rooms, minimum air circulation of 100 ft³/min per kilowatt of loss should be provided.

Do not stack Lineators or install above other heat source equipment.

Enclosures are designed in accordance with NEMA and UL standards and can allow for installation in various environments. Standard enclosures for the Lineator™ are NEMA3R rated.

For derating factors which apply to installations above 3000ft [1000m] refer to Section 7.5 Lineator Type Operational Curve.

3.2 Inspection and Energization

Upon receipt of shipment, the Lineator™ should be inspected for any damage incurred during shipment. Before energization an internal inspection should be conducted with emphasis on loose or broken connections, damaged or displaced parts, cracked insulators, dirt or foreign material, or evidence of moisture. While servicing the Lineator, all relevant safety standards must be followed, including all applicable electrical codes and NFPA 70E – Standard for Electrical Safety in the Workplace.

3.2.1 Before Energization

- Verify that the Lineator external feeder circuit breaker is in the OFF/OPEN position so that unit is de-energized.

- Check all bolts, nuts, screws, and connections for tightness and inspect for broken or damaged components or cables.
- Clean, vacuum, and clear interior of Lineator enclosure of any extra hardware and debris.
- Verify proper three-phase wiring of system power wires, ground, and feeder breaker.
- Check all capacitors for swelling, leaking, or extruded vents; replace if necessary. Verify all fuses for integrity and rating.
- If Lineator has been sitting idle for 6 months or longer before first energization, it is recommended that the maintenance procedure described in 5.0 is performed prior to startup.

3.2.2 Initial Lineator start-up and run

- If test measurements are to be taken, connect any test equipment before energization.
- It is recommended that any test instruments be connected such that all enclosure panels can be installed properly and Lineator can be fully enclosed. Consider using meters with remote wireless displays if possible.
- When energizing, use appropriate personal protection equipment (PPE) and other precautions as required by NFPA 70E.

3.3 Handling

The Lineator™ should be thoroughly protected against the entrance of dust, rain or snow when handled outdoors.

When lifting the Lineator™, the lifting cables should be held apart by a spreader to avoid bending the lifting lugs or other parts of the structure. To access the lifting lugs, remove the top enclosure cover. The Lineator™ may be skidded or moved on rollers but care must be taken not to damage the base or tip it over. When rollers are used under larger units, skids must be used to distribute the stress over the base.

After the Lineator™ is placed in permanent position, shipping braces should be removed and shipping bolts, if present, should be loosened.

Where isolation pads have been included, the bolt should be loosened until the spring washer has been relaxed before putting into service. This will reduce noise resulting from the Lineator's™ natural vibration.

3.4 Grounding

Consideration must be given to equipment grounding (case and core) and must be made in accordance with all applicable electrical codes.

4.0 Storage

Condensation and moisture absorption must be prevented during storage. The Lineator™ must be stored in a warm, dry location. Ventilation openings should be covered to keep out dust. If outdoor storage cannot be avoided, the Lineator™ must be protected to prevent entrance of water, moisture and foreign material.

5.0 Maintenance

Caution: Before entering or working on the Lineator™, it should be de-energized, properly grounded and isolated. Only qualified service technicians should be allowed to maintain the filter. While servicing the Lineator, all relevant safety standards must be followed, including all applicable electrical codes and NFPA 70E – Standard for Electrical Safety in the Workplace.

5.1 Periodic Inspection and Maintenance

The Lineator™ has no moving or active parts and therefore requires only minimal periodic maintenance when installed in a clean and well ventilated environment. Annual maintenance is recommended. This should include:

- 5.1.1 Visual inspection for evidence of loose connections, dirt, moisture, rusting, corrosion, and deterioration of the insulation, varnish or paint. Observations should be made for signs of overheating and overvoltage creeping. Corrective measures should be taken as necessary.
- 5.1.2 For early detection of any developing hotspots, an infrared scan can be performed while the Lineator™ is operating under its heaviest load condition.
- 5.1.3 Lineator™ capacitors are equipped with an internal ‘Tear-Off’ fuse pressure interrupter to prevent explosive failure. At the end of its service life, pressure within a capacitor will build due to the release of gases as its dielectrics breakdown. The covers on the cans are designed to expand or bulge and Tear-Off the internal fuse as this pressure builds. Capacitors should be inspected regularly and replaced when found to have an expanded cover.

- 5.1.4 Even though they may appear fine physically, capacitors may require replacement if their capacitance value has degraded significantly. With the Lineator de-energized and locked out, pull capacitor fuses and measure the capacitance of each capacitor. If this value indicates a drop in capacitance of more than 5%, the capacitor should be replaced.

Caution: Ensure that power to the Lineator™ has been turned off and safely isolated before replacing failed capacitors.

- 5.1.5 Most Lineators™ are also equipped with capacitor fuses. Capacitor fuses are intended to provide additional protection against overloading of the capacitors and upstream reactor. A blown fuse can be detected by checking for illumination of the blown fuse indicator when this option has been purchased or by testing for conductivity. If the blown fuse indicator is on or the fuse is open, it should be replaced.

Caution: Ensure that power to the Lineator™ has been turned off and safely isolated before replacing blown fuses.

- 5.1.6 Measuring the current in each of the 3 phases of the capacitor circuit can be another method of determining the condition of the capacitors. The capacitors can be assumed to be in good operating condition when all 3 phases carry approximately the same amount of load current. Measurements should be taken at the input to the capacitor distribution block and can be done at any loading condition. Phase currents that are imbalanced by more than 10%, indicate a capacitor failure or blown fuse. When the filter capacitor bank has been connected in a wye configuration (ie. two jumpers create a common point on each set of three capacitors), locating the problem capacitor(s) can be achieved by measuring the voltage between the common neutral point of each set to ground. If the voltage difference is greater than 10V, at least one of the capacitors in that set has failed or has a blown fuse. Testing should be conducted annually or whenever the unit seems to be operating in an abnormal manner.

- 5.1.7 The Lineator™ is capable of continued operation with some failed capacitors or blown capacitor fuses. Harmonic mitigation performance will be sacrificed however, so it is recommended that all failed capacitors or blown capacitor fuses be replaced as soon as is practically possible after detection.

5.2 Cleaning

Excessive accumulations of dirt on the reactor windings or insulators and capacitor terminals should be removed to permit free circulation of air and to guard against the possibility of insulation breakdown. Particular attention should be given to cleaning the top and bottom ends of the winding assemblies and to cleaning out ventilating ducts. Windings should be lightly cleaned by the use of a vacuum cleaner. If necessary a blower or compressed air may be used but pressure should not exceed 25 psi. Lead supports, tap changers and terminal boards, bushings, and other major insulating surfaces should be brushed or wiped with a dry cloth. The use of liquid cleaners is not recommended due to deteriorating effects on most insulating materials.

5.3 Drying of Core and Coil Assembly

Caution: Constant attention during the drying process is recommended.

When it is necessary to dry a Lineator™ reactor before installation or after an extended shutdown under relatively high humidity conditions, internal and/or external heating methods can be used. (See ANSI/IEEE C57.94-1982 for a description of these methods).

It is important that most of the heated air pass through the winding ducts and not around the sides. Good ventilation is essential in order that condensation not take place in the reactor itself or inside the case. A sufficient quantity of air should be used to assure approximately equal inlet and outlet temperatures.

During the drying process, ambient air temperature should not exceed 45°C [113°F].

6.0 Operation

Caution: Do not remove covers, shrouds, panels, or any enclosure parts while the Lineator™ is energized.

6.1 Effect of Humidity

While the Lineator™ is energized, humidity conditions are generally not important since the heat from the reactor will prevent condensation. If a shutdown exceeding 24 hours occurs during a period of high humidity that could cause condensation within the reactor, precautions should be taken. Small strip heaters may be energized in the bottom of the unit to maintain the temperature of the unit a few degrees above that of the outside air. If such precautions are not taken the unit should be inspected for evidence of moisture and insulation resistance checked. If necessary, dry as described in Maintenance section above.

6.2 Loading

A Lineator™ should only be loaded in accordance with its nameplate rating.

7.0 Technical Data

7.1 General Specifications

Voltages

All standard voltages up to 690V

Frequency

60Hz and optional 50Hz

Overload Capability

150% for 60 seconds every 10 minutes

Harmonics Treated

5th, 7th, 11th, 13th, ...

K-Factor Suitability

Up to 20

Input K-Factor

Reduced to < 1.5

Input Current Distortion

< 8% @ Full Load

Maximum Capacitive Reactive Current (kVAR as % of rated kW)

5 to 75HP: < 20%
100HP+: < 15%

Efficiency

> 99%

Elevation

≤ 3300ft [1000m] above sea level

Ambient Temperature

≤ 104 Deg F [40 Deg C]

Ventilation

Convection air cooled

Winding Material

Copper

Insulating Varnish Impregnation

Polyester Resin

Enclosure

Type: NEMA-3R (Type-3R)
Paint: Polyester powder coated
Colour: ANSI 61 Grey
Wall Mtg. Capability: 5 to 200HP

7.2 Connection Diagrams

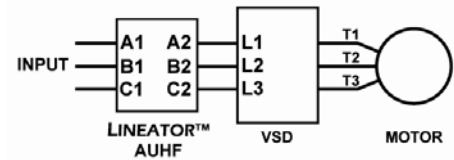

Typical VSD System with Lineator™

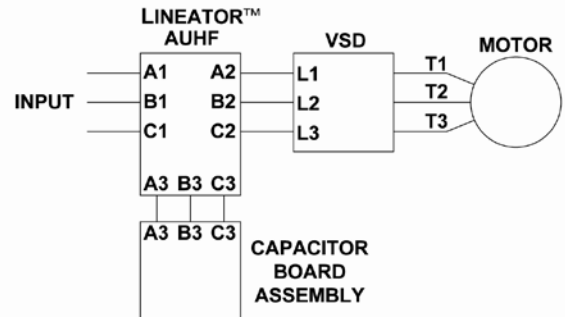

Typical VSD System – Lineator™ and capacitor board shipped loose.

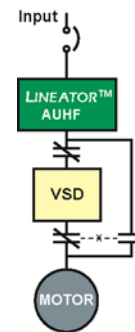

Lineator™ configuration in VSD System with Bypass. This configuration will provide Soft-Start functionality.

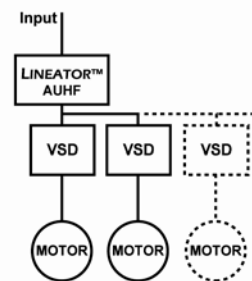

Lineator™ with Multiple VSD System

7.3 Lineator Rating Table

Motor Size		Lineator Rating (3-Phase)								480V (60Hz)				600V (60Hz), 690V (50-60Hz)			
HP	kW	Current Rating (Amps)								Standard Enclosure		Enhanced Enclosure		Standard Enclosure		Enhanced Enclosure	
		460/480V 60Hz		575/600V 60Hz		660/690V 50/60Hz		Output		Case Style	Weight lbs [kg] ^[1]	Case Style	Weight lbs [kg] ^[1]	Case Style	Weight lbs [kg] ^[1]	Case Style	Weight lbs [kg] ^[1]
		Input	Output	Input	Output	Input	Output	kVA	kW								
5	4	7	7	5	5	5	5	6	4.5	SU1	58 [26]	SU1-E	68 [31]	SU1	57 [26]	SU1-E	67 [30]
7.5	5.5	9	10	7	7	6	6	8	6.3		67 [30]		77 [35]		67 [30]		77 [35]
10	7.5	12	13	10	11	8	8	10	8.5		78 [35]		88 [40]		77 [35]		87 [39]
15	11	17	18	14	15	12	13	14	13		90 [41]		100 [45]		86 [39]		96 [44]
20	15	23	24	18	19	16	17	19	17		118 [54]		128 [58]		98 [45]		128 [58]
25	18.5	29	31	23	24	20	21	25	21	SU2	130 [59]	SU2-E	140 [64]	SU2	125 [57]	SU2-E	135 [61]
30	22	34	36	28	30	24	25	29	25		142 [65]		152 [69]		137 [62]		147 [67]
40	30	46	49	37	39	32	34	39	34		154 [70]		164 [74]		149 [68]		159 [72]
50	37.5	57	60	45	48	40	42	48	42	SU3	186 [84]	SU3-E	196 [89]	SU3	184 [83]	SU3-E	196 [89]
60	45	69	73	55	58	48	51	58	51		218 [99]		228 [103]		206 [94]		216 [98]
75	55	85	90	68	72	59	63	72	63		304 [138]		314 [142]		298 [135]		308 [140]
100	75	113	120	90	95	79	84	96	84	SU4	323 [147]	SU4-E	333 [151]	SU4	315 [143]	SU4-E	325 [147]
125	90	141	149	112	119	98	104	119	104		345 [156]		419 [191]		345 [156]		419 [191]
150	110	169	179	135	143	118	125	143	125		365 [166]		439 [200]		365 [166]		439 [200]
175	132	200	212	159	169	139	147	166	148	SU4	390 [177]	MT3-E	455 [207]	SU4	390 [177]	MT3-E	455 [207]
200	150	226	240	180	191	158	167	191	168		415 [189]		489 [222]		415 [189]		489 [222]
250	185	281	298	225	239	196	208	237	209	MT3	578 [262]	MT4-E	640 [290]	MT3	578 [262]	MT4-E	640 [290]
300	220	337	357	270	286	235	249	284	251		585 [266]		695 [316]		585 [266]		695 [316]
350	250	395	419	315	334	275	292	334	292	MT4	800 [363]	LT1-E	1006 [456]	MT4	780 [354]	LT1-E	1006 [456]
400	315	470	498	375	398	325	345	397	349		825 [374]		1031 [467]		805 [365]		1031 [467]
450	355	530	562	424	449	369	391	448	394		870 [395]		1076 [488]		870 [395]		1076 [488]
500	400	595	631	475	504	415	440	503	443	LT1	915 [415]	LT2-E	1121 [508]	LT1	915 [415]	LT2-E	1121 [510]
600	450	670	710	535	567	470	498	566	499		1398 [634]		1476 [670]		1398 [634]		1476 [670]
700	500	780	827	625	663	545	578	659	579	LT2	1700 [771]	LT3-E	1839 [834]	LT2	1650 [748]	LT3-E	1740 [789]
800	560	890	943	715	758	620	657	751	662		1882 [854]		1954 [886]		1805 [819]		1852 [842]
900	630	990	1049	795	843	690	731	836	736	LT3	1920 [871]	HT2-E / LT4-E	2054 [931]	LT3	1882 [854]	HT2-E / LT4-E	2054 [932]
1000	710	1100	1166	880	933	770	816	929	818		1950 [884]		2084 [945]		1915 [869]		2064 [936]
1100	800	1210	1283	970	1028	845	896	1022	900		2465 [1118]		2564 [1163]		2331 [1057]		2515 [1141]
1200	900	1330	1410	1060	1124	925	981	1123	987	HT2 / LT4	2568 [1167]	HT3-E	2958 [1245]	HT2 / LT4	2465 [1121]	HT3-E	2855 [1298]
1300	970	1430	1516	1145	1214	1000	1060	1208	1064		2718 [1236]		3408 [1549]		2609 [1186]		2999 [1363]
1400	1000	1540	1632	1235	1309	1075	1140	1300	1145	HT3	2858 [1299]	HT3-E	3548 [1613]	HT3	2782 [1265]	HT3-E	3172 [1442]
1500	1120	1650	1749	1325	1405	1155	1224	1394	1228		3598 [1635]		3690 [1677]		3540 [1606]		3620 [1642]
1600	1200	1770	1876	1415	1500	1235	1309	1495	1316		3748 [1703]		3840 [1745]		3702 [1679]		3800 [1724]
1800	1350	1990	2109	1595	1691	1390	1473	1680	1481	HT3	3848 [1749]	HT3-E	4376 [1943]	HT3	3798 [1723]	HT3-E	3875 [1758]
2000	1450	2200	2332	1765	1871	1535	1627	1858	1636		3978 [1808]		4506 [2048]		3945 [1789]		4250 [1928]
2300	1700	2530	2682	2030	2152	1765	1871	2137	1882		4075 [1850]		4600 [2088]		4015 [1821]		4340 [1969]
2500	1850	2755	2920	2205	2337	1920	2035	2326	2045	HT3	4650 [2111]	HT3-E	4750 [2157]	HT3	4600 [2087]	HT3-E	4750 [2155]
2800	2100	3100	3286	2480	2629	2160	2290	2618	2303		5000 [2270]		5100 [2315]		4945 [2243]		5100 [2313]
3000	2250	3320	3519	2660	2820	2315	2454	2804	2468		5225 [2372]				5180 [2350]		
3500	2600	3855	4086	3085	3270	2685	2846	3255	2825		5550 [2520]		5490 [2490]				

1. Approximate Values

Rating Table (continued)

Motor Size		Lineator Rating (3-Phase)										208, 240V (60Hz)				400, 440V (50Hz)			
HP	kW	Current Rating (Amps)										Standard Enclosure		Enhanced Enclosure		Standard Enclosure		Enhanced Enclosure	
		208V 60Hz		220/240V 50/60Hz		380/400V 50Hz		415/440V 50Hz		Output		Case	Weight	Case	Weight	Case	Weight	Case	Weight
		I/P A	O/P A	I/P A	O/P A	I/P A	O/P A	I/P A	O/P A	kVA	kW	Style	lbs [kg] ^[1]	Style	lbs [kg] ^[1]	Style	lbs [kg] ^[1]	Style	lbs [kg] ^[1]
5	4	14	15	13	14	8	8	7	7	6	4.5	SU1	65 [30]	SU1-E	75 [34]	SU1	58 [26]	SU1-E	68 [31]
7.5	5.5	20	21	18	19	11	12	10	11	8	6.3		76 [35]		86 [39]		67 [30]		77 [35]
10	7.5	27	29	24	25	14	15	13	14	10	8.5	SU2	80 [36]	SU2-E	80 [36]	SU2	90 [41]	SU2-E	100 [45]
15	11	40	42	36	38	21	22	19	20	14	13		117 [53]		127 [58]		118 [54]		128 [58]
20	15	53	56	48	51	28	30	25	27	19	17		138 [63]		148 [67]		130 [59]		140 [64]
25	18.5	66	70	60	64	35	37	32	34	25	21	SU3	154 [70]	SU3-E	164 [74]	SU2	142 [65]	SU2-E	152 [69]
30	22	79	84	72	76	42	45	38	40	29	25		189 [86]		199 [90]		154 [70]		164 [74]
40	30	105	111	95	101	55	58	51	54	39	34	SU3	253 [115]	SU4-E	263 [119]	SU3	186 [84]	SU3-E	196 [88]
50	37.5	131	139	119	126	69	73	63	67	48	42		275 [125]		333 [151]		218 [99]		228 [103]
60	45	158	167	143	152	83	88	76	81	58	51		315 [143]		337 [153]		304 [138]		314 [142]
75	55	196	208	178	189	103	109	95	101	72	63	SU4	325 [148]	MT3-E	399 [181]	SU3	323 [147]	SU4-E	414 [188]
100	75	260	276	236	250	137	145	125	133	96	84		442 [201]		516 [235]		345 [156]		434 [197]
125	90	323	342	294	312	170	180	156	165	119	104	SU4	468 [213]	MT3-E	542 [246]	SU4	365 [166]	MT3-E	469 [213]
150	110	388	411	353	374	204	216	187	198	143	125		553 [251]		627 [285]		615 [279]		390 [177]
175	132	453	480	412	436	241	255	221	234	166	148	MT3	600 [272]	MT4-E	720 [327]	MT3	415 [189]	MT4-E	514 [234]
200	150	517	548	470	499	274	290	250	265	191	168		700 [318]		1000 [453]		578 [262]		600 [273]
250	185	647	686	588	623	340	360	312	331	237	209	MT4	850 [386]	LT1-E	1150 [522]	MT4	585 [266]	MT4-E	670 [305]
300	220	776	823	706	748	410	435	374	396	284	251		1125 [510]		1350 [612]		800 [363]		1006 [456]
350	250	906	960	823	873	475	504	436	462	334	292	LT1	1250 [567]	LT2-E	1500 [680]	MT4	825 [374]	LT1-E	1031 [467]
400	315	1035	1097	941	997	565	599	520	551	397	349		1325 [601]		1500 [680]		870 [395]		1076 [488]
450	355					641	679	587	622	448	394	LT1		LT2-E		LT1	915 [415]	LT2-E	1121 [508]
500	400					720	763	660	700	503	443						1098 [499]		1176 [535]
600	450					810	859	740	784	566	499	LT2		LT3-E		LT2	1700 [771]	LT3-E	1839 [834]
700	500					940	996	865	917	659	579						1882 [854]		1954 [886]
800	560					1075	1140	985	1044	751	662	LT3		HT2-E / LT4-E		LT2		HT2-E / LT4-E	1954 [886]
900	630					1200	1272	1100	1166	836	736						1920 [871]		2054 [931]
1000	710					1335	1415	1220	1293	929	818	LT3		HT3-E		LT3		HT3-E	2084 [945]
1100	800					1470	1558	1340	1420	1022	900						1950 [884]		2564 [1163]
1200	900					1610	1707	1470	1558	1123	987	HT2 / LT4		HT3-E		HT3		HT3-E	2958 [1245]
1300	970					1735	1839	1585	1680	1208	1064						2568 [1167]		3408 [1549]
1400	1000					1870	1982	1710	1813	1300	1145	HT2 / LT4		HT3-E		HT3		HT3-E	3548 [1613]
1500	1120					2000	2120	1835	1945	1394	1228						2718 [1236]		3690 [1677]
1600	1200					2145	2274	1965	2083	1495	1316	HT3		HT3-E		HT3		HT3-E	3840 [1745]
1800	1350					2410	2555	2210	2343	1680	1481						2858 [1299]		3748 [1703]
2000	1450					2670	2830	2440	2586	1858	1636	HT3		HT3-E		HT3		HT3-E	4506 [2048]
2300	1700					3065	3249	2810	2979	2137	1882						3978 [1808]		4075 [1850]
2500	1850					3335	3535	3050	3233	2326	2045	HT3		HT3-E		HT3		HT3-E	4750 [2157]
2800	2100					3750	3975	3435	3641	2618	2303						4650 [2111]		5000 [2270]
3000	2250					4020	4261	3680	3901	2804	2468	HT3		HT3-E		HT3		HT3-E	
3500	2600					4265	4521	3905	4139	3255	2825						5225 [2372]		5550 [2520]

1. Approximate Values

7.4 Recommended Circuit Breaker or Fuse Protection Table

Lineator Size		Recommended Circuit Breaker or Fuse Sizes – NEC [IEC]						
HP	kW	460/ 480V 60Hz NEC	575/ 600V 60Hz NEC	660/ 690V 50/60Hz NEC [IEC]	208V 60Hz NEC	220/ 240V 50/60Hz NEC [IEC]	380/ 400V 50Hz IEC	415/ 440V 50Hz IEC
5	4	10	10	10	20	20	10	10
7.5	5.5	15	10	10	25	25	16	16
10	7.5	15	15	10	35	30	20	16
15	11	25	20	15	50	45	32	25
20	15	30	25	20	70	60	35	32
25	18.5	40	30	25	90	80	45	40
30	22	45	35	30	100	90	63	50
40	30	60	45	40	150	125	80	63
50	37.5	80	60	50	175	150	100	80
60	45	90	70	60	200	200	125	100
75	55	125	90	80	250	225	160	125
100	75	150	125	100	350	300	200	160
125	90	175	150	125	400	400	224	200
150	110	225	175	150	500	450	250	250
200	150	300	225	200			350	315
250	185	350	300	250			425	400
300	220	450	350	300			560	500
350	250	500	400	350			630	630
400	315	600	500	400			710	710
500	400	700	600	500			900	800
600	450	800	700	600			1000	1000
700	500	1000	800	700			1250	1000
800	560	1200	900	800			1600	1250
900	630	1200	1000	900			1600	1600
1000	710	1400	1200	1000			2000	1600
1100	800	1600	1200	1200			2000	1600
1200	900	1800	1400	1200			2000	2000
1300	970	1800	1400	1200			2500	2000
1400	1000	2000	1600	1400			2500	2500
1500	1120	2000	1800	1400			2500	2500
1600	1200	2500	1800	1600			3000	2500
1800	1350	2500	2000	1800			3200	3000
2000	1450	3000	2500	2000			3200	3200
2300	1700	4000	2500	2500			4000	4000
2500	1850	4000	3000	2500			4000	4000
2800	2100	4000	3000	3000			5000	5000
3000	2250	5000	4000	3000			5000	5000
3500	2600	5000	4000	4000			6000	5000

1. These are recommended values only and do not supersede the local code requirements. Refer to NEC and/or IEC sizing rules for overcurrent protection device.
2. 100% - rated circuit breakers recommended for continuous load.

7.5 Lineator Type Operational Curve

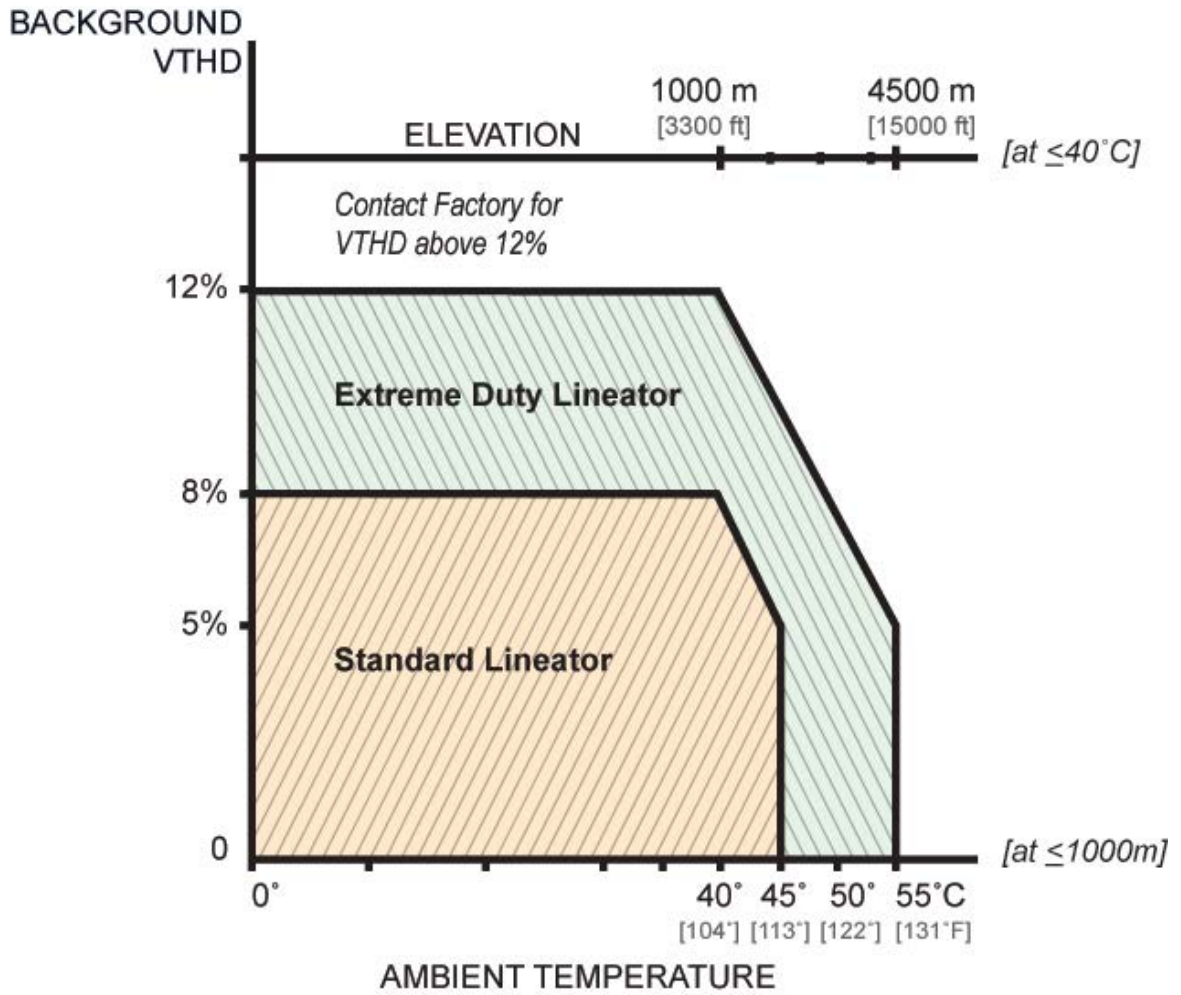

7.6 Enclosure Dimensions

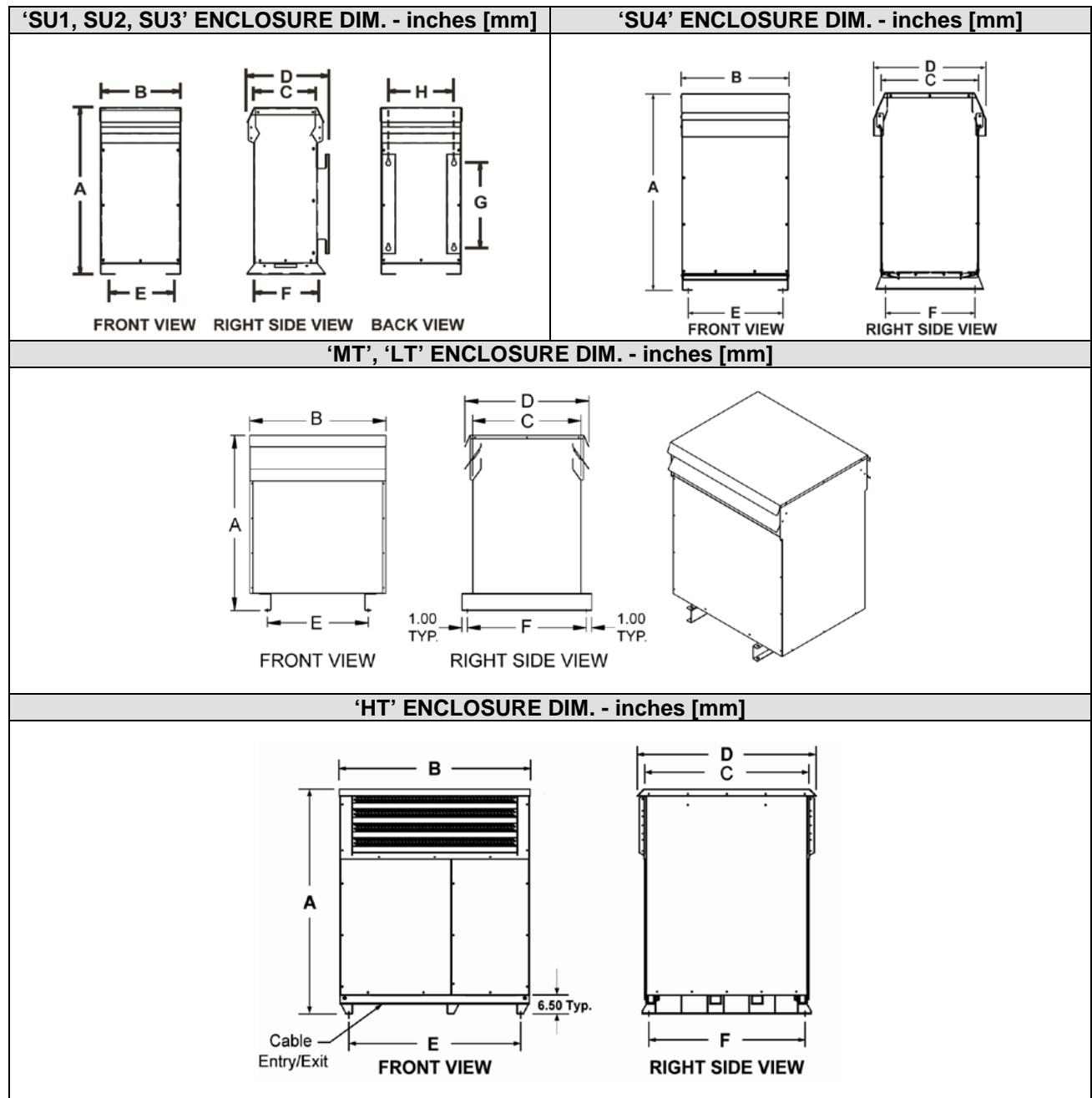

CASE STYLE		ENCLOSURE DIMENSIONS - inches [mm]							
Standard	Enhanced	A	B	C	D	E	F	G	H
SU1	SU1-E	23.50 [597]	11.25 [286]	8.75 [222]	11.25 [286]	9.00 [229]	9.50 [242]	12.00 [305]	9.00 [228]
SU2	SU2-E	30.00 [762]	13.25 [336]	10.25 [260]	12.75 [324]	11.00 [279]	11.25 [286]	16.00 [406]	11.00 [279]
SU3	SU3-E	34.00 [864]	20.25 [514]	13.25 [336]	16.00 [406]	18.00 [457]	14.25 [362]	20.00 [508]	18.00 [457]
SU4	SU4-E	40.00 [1016]	22.00 [559]	19.75 [502]	22.00 [559]	20.00 [508]	20.00 [508]		
MT3	MT3-E	45.00 [1143]	26.00 [661]	21.00 [534]	25.00 [635]	21.50 [546]	19.00 [483]		
MT4	MT4-E	51.50 [1308]	32.00 [813]	25.50 [648]	29.50 [749]	23.50 [597]	23.50 [597]		
LT1	LT1-E	59.00 [1499]	39.50 [1003]	30.00 [762]	34.00 [864]	24.00 [610]	32.00 [813]		
LT2	LT2-E	66.00 [1677]	44.00 [1118]	34.00 [864]	38.00 [965]	26.00 [660]	36.00 [915]		
LT3	LT3-E	75.00 [1905]	48.50 [1232]	39.00 [991]	43.00 [1092]	27.50 [699]	41.00 [1041]		
LT4	LT4-E	78.00 [1981]	59.00 [1499]	50.50 [1283]	54.25 [1378]	32.00 [813]	52.00 [1321]		
HT2	HT2-E	78.00 [1981]	59.00 [1499]	52.00 [1321]	56.25 [1442]	54.00 [1372]	52.00 [1321]		
HT3	HT3-E	84.00 [2134]	69.00 [1753]	59.50 [1511]	64.50 [1638]	64.00 [1626]	60.00 [1524]		

8.0 Troubleshooting Guide

Caution: Before entering or working on the Lineator™, it should be de-energized, properly grounded and isolated. Work that requires that the filter be energized, must only be performed by a qualified technician.

1. PROBLEM: No power to Lineator™

- a. Possible cause: Power to the filter is turned off.

Solution: Check that upstream circuit breaker is closed or that fuses are installed in upstream fused disconnect and are not blown.

2. PROBLEM: Capacitor phase currents are unbalanced by more than 10%

- a. Possible cause: One or more capacitors have failed.

Solution: Most Lineator™ filters have their capacitors connected in a wye configuration (ie. two jumpers create a common point on each set of three capacitors). Locating a failed capacitor can be simplified by measuring the voltage between the common neutral point of each set to ground while the filter is energized. If the voltage difference is greater than 10V, at least one of the capacitors in that set has failed or has a blown fuse. With power to the Lineator™ turned off and safely isolated, check for evidence of failure in the form of a bulged case. Replace any failed capacitors.

- b. Possible cause: Blown capacitor fuse.

Solution: If equipped with the blown fuse indicator option, check all capacitor fuse blocks for evidence of a blown fuse. If not equipped with blown fuse indicators, measure the voltage across the terminals of each fuseholder with power applied to the filter. If voltage is not near 0, fuse is blown and should be replaced. Make sure that fuse rating used is appropriate for capacitor size. Check with the factory for fuse sizing. To simplify location of a blown capacitor fuse, check the voltage between the common neutral point of each set of three capacitors to ground as per Item 2a above.

3. PROBLEM: Harmonic mitigation performance does not seem to match performance guarantee

- a. Possible cause: ITHD measurement is being used instead of ITDD.

Solution: Check loading of VFD and determine ITDD value by multiplying measured ITHD value by percent loading. Check this value against performance guarantee.

- b. Possible cause: One or more capacitors have failed.

Solution: Check for failed capacitor and replace if necessary (see Item 2a).

- c. Possible cause: One or more capacitor fuses have blown.

Solution: Check for blown capacitor fuse and replace if necessary (see Item 2b).

- d. Possible cause: High background voltage distortion.

Solution: Check that background voltage distortion is below 5%. If above 5%, consider harmonic mitigation for other harmonic generating loads.

4. PROBLEM: Lineator™ output voltage is not within specification

- a. Possible cause: Filter input voltage is not within specification.

Solution: Check the AC input voltage and verify that it is within specification. Change upstream transformer taps if necessary.

- b. Possible cause: One or more capacitors have failed.

Solution: Check for failed capacitor and replace if necessary (see Item 2a).

- c. Possible cause: One or more capacitor fuses have blown.

Solution: Check for blown capacitor fuse and replace if necessary (see Item 2b).



MIRUS International Inc.
31 Sun Pac Blvd.
Brampton, Ontario
Canada L6S 5P6

1 - 888 - TO - MIRUS (1 - 888 - 866 - 4787)
Tel: (905) 494-1120
Fax: (905) 494-1140
E-Mail: mirus@mirusinternational.com
Website: www.mirusinternational.com